

# IRUKI



**BARBACOA DE CARBÓN**

**Barbacoa AVENTURA**

**EN – Charcoal barbecue**

**FR – Barbecue à charbon de bois**

**PT – Churrasqueira a carvão**

I.      **INSTALACIÓN**  
**INSTALLATION**  
**INSTALLATION**  
**INSTALAÇÃO**

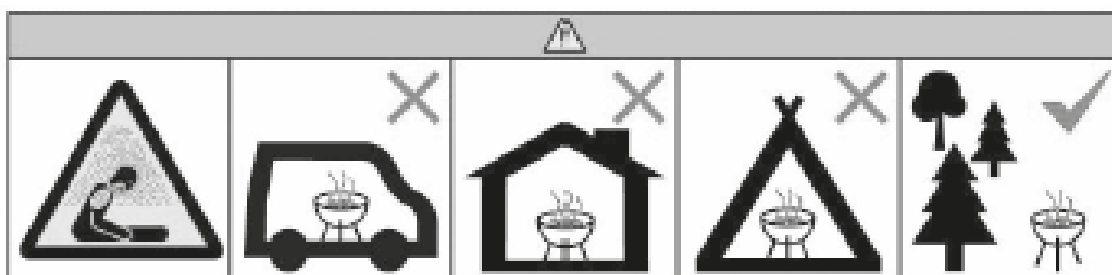

**ES** - No utilizar la barbacoa en un espacio cerrado y/o habitable, por ejemplo, en casas, tiendas, caravanas, autocaravanas, barcos. **Puede causar la muerte por intoxicación con monóxido de carbono.**

**FR** - Ne pas utiliser le barbecue dans un espace confiné et/ou habitable par exemple des maisons, tentes, caravanes, camping-cars, bateaux. **Risque de décès par em-poisonnement au monoxyde de carbone.**





**EN** - Do not use the barbecue in a confined and/or habitable space e.g. houses, tents, caravans, motor homes, boats. **Danger of carbon monoxide poisoning fatality.**

**PT** - Não utilizar o churrasco num espaço confinado e/ou habitável, por exemplo em casa, tendas, caravanas, camping-cars, barcos. **Risco de morte por envenenamento por monóxido de carbono.**

# IRUKI

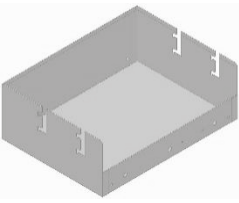
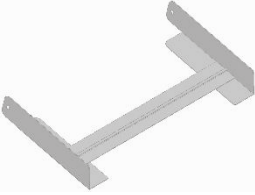
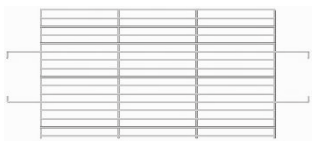
## I. Instalación installation installation instalação

COMPONENTES: COMPONENTE: COMPOSANTS: COMPONENTS:

MOMBRE NOME NOM NAME	IMAGEN IMAGE IMAGE IMAGE	UNIDADES UNITS UNITÉS UNITS
CUBA BBQ. / CORPO DO BBQ CORPS / BBQ BODY		1
PATAS / JUROS/ JAMBES / LEGS		2
PARRILLA / GRILL / GRILLE / GRILL		1
ASA PARRILLAS / CABO DE GREHAS / POIGNÉE DE GRILLES / GRILL HANDLES		2
TORNILLO CRUZ M6X12 / PARAFUSO M6x12 / VIS CROISÉE M6x12 / CROSS SCREW M6x12		4
TUERCA FRENO M6 / PORCA TRAVÃO M6 / VIS FREINER M6 / BRAKED SCREW M6		4
ARANDELA M6 / ARRUELA M6 / LAVE M6 / WASHER M6		4

1

2-M6

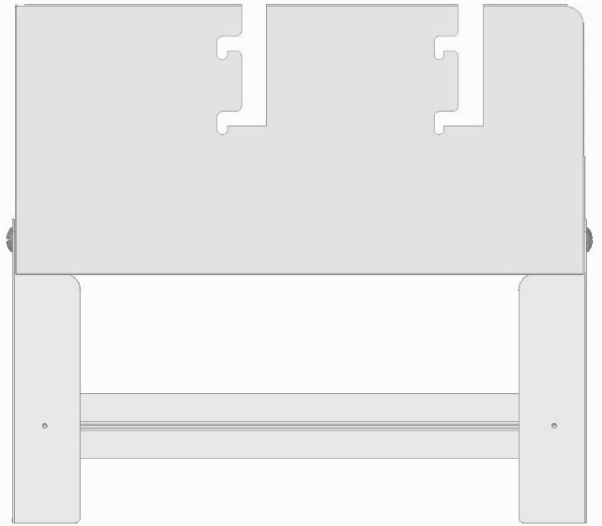
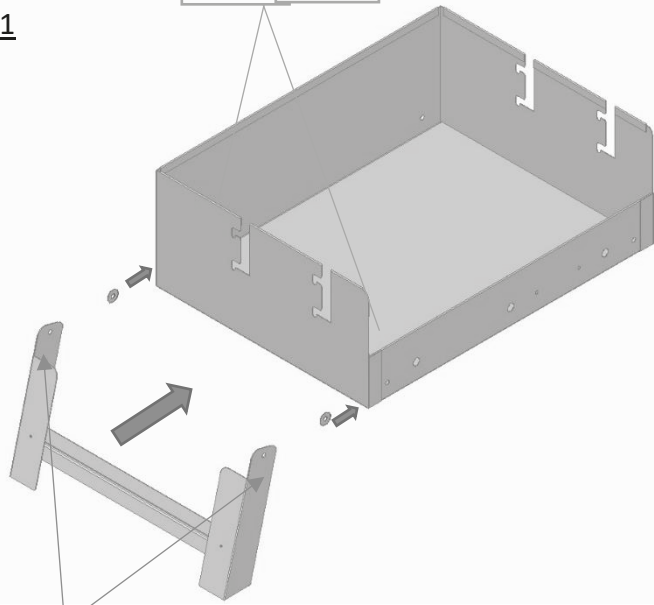

2-M6X12

2

2-M6

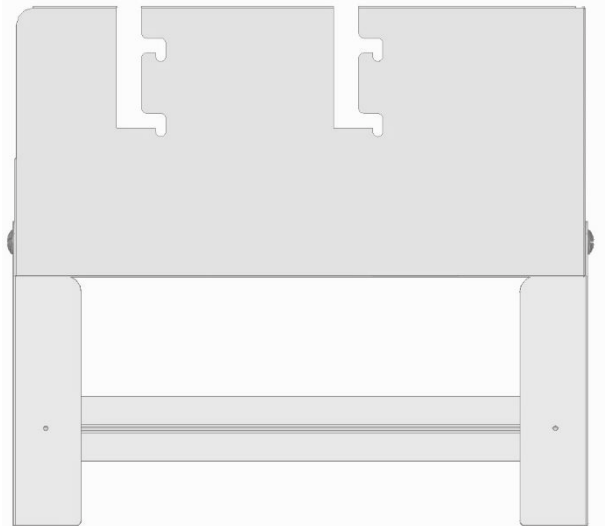
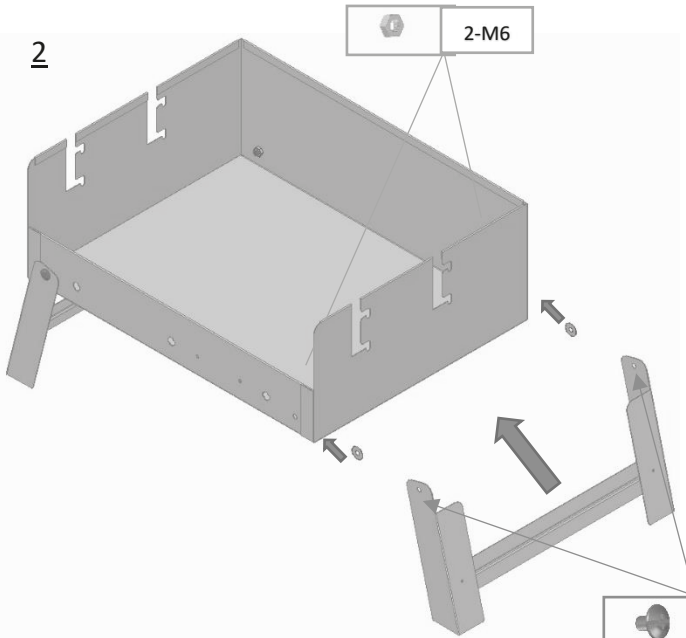

2-M6X12



IRUKI

3

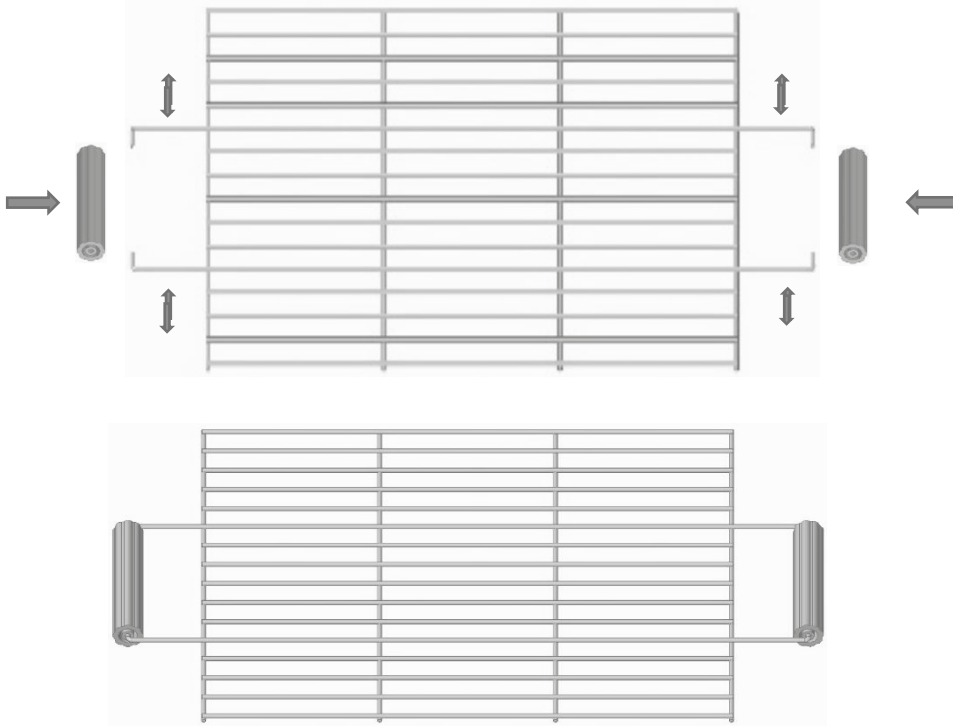

4

